

DISPLAY INNOVATIONS

800-583-9691 **INCORPORATED**

Catalog

And

Price List

SPECIALTY HARDWARE FOR THE DISPLAY INDUSTRY

Visit us on the web at:
www.displayinnovations.com
e-mail: sales@displayinnovations.com

Catalog updated **FEBRUARY 2009**

Display Innovations, Incorporated
2591 Carver Avenue
St. Paul, Minnesota 55119
Phone: (651) 735-0120
Fax: (651)-735-7314

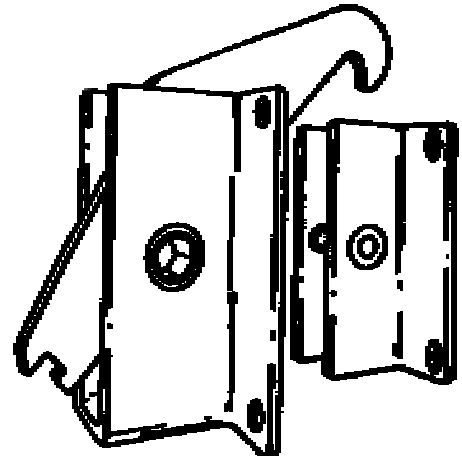

PANEL LOCK SETS: QUANTITY, 1 TO 100-----\$8.95 PER SET
 QUANTITY, 101 TO 250-----\$8.50 PER SET
 QUANTITY, 251 TO 500-----\$8.05 PER SET
 QUANTITY, 501 TO 1000-----\$7.60 PER SET

PANEL LOCK HOOK: (MALE HALF ONLY)-----\$7.25 EACH
 (When purchased separately, the lock portion or strike portion of the set receives the same quantity discount as complete sets receive; 5%, 10%, and 15%.)

PANEL LOCK STRIKES:	SIZE	WORK THICKNESS	PRICE
FOR 1 7/16" WORK THICKNESS, USE OUR STANDARD 7/16" STRIKE AND TWO OF OUR 1/16" THICK SPACER PLATES AT A COST OF-----\$.72 PER PAIR			
PANEL LOCK STRIKE: (FEMALE)	7/16"	OUR STANDARD-1-1/2"	\$1.70 EACH
PANEL LOCK STRIKE: (FEMALE)	1/2"	1-9/16"	\$2.20 EACH
PANEL LOCK STRIKE: (FEMALE)	5/8"	1-11/16"	\$2.20 EACH
PANEL LOCK STRIKE: (FEMALE)	11/16"	1-3/4"	\$2.20 EACH
PANEL LOCK STRIKE: (FEMALE)	3/4"	1-13/16"	\$2.20 EACH
PANEL LOCK STRIKE: (FEMALE)	13/16"	1-7/8"	\$2.20 EACH
PANEL LOCK STRIKE: (FEMALE)	1-1/8"	2-1/16"	\$2.20 EACH

SPACER PLATES ONLY: TO CONVERT 7/16" STRIKES TO 3/8" STRIKES.
 TYPICALLY REQUIRED WHEN PLYWOOD IS USED FOR PANEL STILES-----\$.72 PER PAIR

PANEL LOCK WRENCHES: 5/16" HEX, L SHAPED, 5" EACH LEG-----\$4.25 EACH
 5/16" HEX, L SHAPED, 5" ONE LEG
 AND 12" OTHER LEG-----\$5.50 EACH
 MADE TO YOUR SIZE REQUIREMENTS-----\$10.00 EACH

DRILLING KIT: FOR DRILLING THE WRENCH ACCESS HOLE IN THE
 FACE OF DISPLAY PANELS-----\$44.00 PER KIT

HOLE PLUGS:
 3/8"--DIAMETER, UNFINISHED STEEL-----\$25.00 PER 100
 1/4"--DIAMETER, PLASTIC, IN BLACK, OR WHITE-----\$20.00 PER 250
 5/16"--DIAMETER, PLASTIC, IN BLACK, OR WHITE-----\$20.00 PER 250
 3/8"--DIAMETER, PLASTIC, IN BLACK, OR WHITE-----\$20.00 PER 250
 7/16"--DIAMETER, PLASTIC, IN BLACK, OR WHITE-----\$20.00 PER 250
 1/2"--DIAMETER, PLASTIC, IN BLACK, OR WHITE-----\$20.00 PER 250
 1/4" DIAMETER, 27/64" HEAD DIA., NYLON/MATTE/NATURAL-----\$20.00 PER 250
 5/16" DIAMETER, 29/64" HEAD DIA., NYLON/MATTE/NATURAL-----\$20.00 PER 250
 3/8" DIAMETER, 37/64" HEAD DIA., NYLON/MATTE/NATURAL-----\$20.00 PER 250
 7/16" DIAMETER, 39/64" HEAD DIA., NYLON/MATTE/NATURAL-----\$20.00 PER 250
 1/2" DIAMETRE, 43/64" HEAD DIA., NYLON/MATTE/NATURAL-----\$20.00 PER 250

CARRIAGE BOLTS: 1/4-20 X 1-1/2"-----\$42.00 PER CASE OF 1000, \$6.60 PER 100
 1/4-20 X 2"-----\$41.00 PER CASE OF 800, \$7.95 PER 100
 1/4-20 X 2-1/2"-----\$44.00 PER CASE OF 700, \$9.50 PER 100
 1/4-20 X 3"-----\$43.00 PER CASE OF 600, \$11.00 PER 100
 1/4-20 X 6"-----\$41.00 PER CASE OF 300, \$21.00 PER 100

TORQUE WASHERS 1/4" :-----250 TO 1000 PIECES, PER 250, \$58.70
(FOR 1/4" CARRIAGE BOLTS) 1250 PLUS PIECES, PER 250, \$52.50

EXHIBIT BOLTS: 1/4-20 X 1"-----PER 100, \$24.50
1/4-20 X 2"-----PER 100, \$28.75
1/4-20 X 2-1/2"-----PER 100, \$34.00
1/4-20 X 3"-----PER 100, \$38.50

WING NUTS: 1/4-20 WITH 7/8" WASHER BASE-----500 PIECES, \$85.00
1000 TO 4999 PIECES, PER THOUSAND, \$155.00
5000 PLUS PIECES, PER THOUSAND, \$135.00
5/16-18 WITH 7/8" WASHER BASE-----500 PIECES, \$95.00
1000 TO 4999 PIECES, PER THOUSAND, \$155.00
5000 PLUS PIECES, PER THOUSAND, \$135.00
3/8-16 WITH 7/8" WASHER BASE-----500 PIECES, \$95.00
1000 TO 4999 PIECES, PER THOUSAND, \$155.00
5000 PLUS PIECES, PER THOUSAND, \$135.00

WING SCREW: 1/4-20 X 1/2", 3/4", 1", AND 1 1/2"
100 TO 2000 PIECES, PER 100, \$34.00
2100 OR MORE PIECES, PER 100, \$32.00

THUMB SCREWS: 1/4-20 X 2 1/2"-----100 PIECES FOR \$28.50
CASE OF 500 FOR \$88.50

TEE NUTS: 1/4-20-----250 PIECES, \$59.00
5/16-18-----100 PIECES, \$41.00
3/8-16-----100 PIECES, \$26.00

HEX DRIVE, KNIFE THREAD, INSERTS:

1/4-20 INTERNAL THREADS X 1/2" LONG-----100 PIECES, \$19.00
1/4-20 INTERNAL THREADS X 3/4" LONG-----100 PIECES, \$22.00
5/16-18 INTERNAL THREADS X 1" LONG-----100 PIECES, \$26.30
3/8-16 INTERNAL THREADS X 1" LONG-----100 PIECES, \$51.65
6mm HEX DRIVER FOR 1/4-20 HEX DRIVE INSERTS-----\$4.30 EACH
8mm HEX DRIVER FOR 5/16-18 HEX DRIVE INSERTS-----\$8.40 EACH
10mm HEX DRIVER FOR 3/8-16 HEX DRIVE INSERTS-----\$10.20 EACH

KNIFE THREAD INSERTS (Non hex drive):

1/4-20 INTERNAL THREADS-----100 PIECES, \$35.00
DRIVER FOR KNIFE THREAD INSERTS-----\$11.00 EACH

VENT PLUGS: 1" DIAMETER, PLASTIC, IN BLACK-----\$17.50 PER 100
1 1/2" DIAMETER, PLASTIC, IN BLACK-----\$28.00 PER 100
2" DIAMETER, PLASTIC, IN BLACK-----\$36.00 PER 100

HAND HOLE PLUGS:

4" HOLE DIAMETER, 4 3/16" OVERALL DIAMETER-----50 FOR \$130.00, OR \$2.60 EACH

CRATE HINGES AND HASPS: 6" STANDARD HASP WITH KEEPER--1-50 PIECES AT \$3.90
51 PIECES PLUS AT \$3.70
6" SAFETY HASPS-----1-50 PIECES AT \$3.75
51 PIECES PLUS AT \$3.55
6" STANDARD DUTY STRAP HINGE--1-50 PIECES AT \$2.00
51 PLUS PIECES AT \$1.90
6" HEAVY DUTY STRAP HINGE-----1-50 PIECES AT \$3.00
51 PLUS PIECES AT \$2.85
8" HEAVY DUTY STRAP HINGE-----1-50 PIECES AT \$3.99
51 PLUS PIECES AT \$3.80

CRATING AND PACKING FELT:

1/4" THICK X 50' X 1" WIDE ROLL **W/ADHESIVE BACK**-----1-10 ROLLS \$12.05
11 PLUS ROLLS AT \$11.30
1/4" THICK X 50' X 1 1/2" WIDE ROLL **W/ADHESIVE BACK**-----1-10 ROLLS \$17.00
11 PLUS ROLLS AT \$16.25
1/4" THICK X 50' X 2" WIDE ROLL **W/ADHESIVE BACK**-----1-10 ROLLS \$21.85
11 PLUS ROLLS AT \$21.10
1/4" THICK X 50' X 3" WIDE ROLL **W/ADHESIVE BACK**-----1-10 ROLLS \$30.75
11 PLUS ROLLS AT \$30.00
1/4" THICK X 50' X 1" WIDE ROLL, **NO ADHESIVE**-----1-10 ROLLS \$9.10
11 PLUS ROLLS AT \$8.35
1/4" THICK X 50' X 1 1/2" WIDE ROLL, **NO ADHESIVE**-----1-10 ROLLS \$12.65
11 PLUS ROLLS AT \$11.90
1/4" THICK X 50' X 2" WIDE ROLL, **NO ADHESIVE**-----1-10 ROLLS \$16.05
11 PLUS ROLLS AT \$15.30
1/4" THICK X 50' X 3" WIDE ROLL, **NO ADHESIVE**-----1-10 ROLLS \$22.40
11 PLUS ROLLS AT \$21.65
1/8" THICK X 100' X 1" WIDE ROLL **W/ADHESIVE BACK**-----1-10 ROLLS \$13.70
11 PLUS ROLLS AT \$12.95
1/8" THICK X 100' X 1 1/2" WIDE ROLL **W/ADHESIVE BACK**-----1-10 ROLLS \$19.10
11 PLUS ROLLS AT \$18.35
1/8" THICK X 100' X 2" WIDE ROLL **W/ADHESIVE BACK**-----1-10 ROLLS \$26.60
11 PLUS ROLLS AT \$25.85
1/8" THICK X 100' X 3" WIDE ROLL **W/ADHESIVE BACK**-----1-10 ROLLS \$35.20
11 PLUS ROLLS AT \$34.45
1/8" THICK X 100' X 1" WIDE ROLL, **NO ADHESIVE**-----1-10 ROLLS \$9.40
11 PLUS ROLLS AT \$8.65
1/8" THICK X 100' X 1 1/2" WIDE ROLL, **NO ADHESIVE**-----1-10 ROLLS \$12.65
11 PLUS ROLLS AT \$11.90
1/8" THICK X 100' X 2" WIDE ROLL, **NO ADHESIVE**-----1-10 ROLLS \$16.05
11 PLUS ROLLS AT \$15.30
1/8" THICK X 100' X 3" WIDE ROLL, **NO ADHESIVE**-----1-10 ROLLS \$22.45
11 PLUS ROLLS AT \$21.70

A NOTE ON ELECTRICAL CORDS: BECAUSE OF THE CURRENT VOLATILITY OF THE COPPER MARKET, WE ARE NOT ABLE TO PUBLISH PRICES FOR MOST OF OUR CORDS. ALL ORDERS WILL BE PRICED AS PLACED. WE APOLOGIZE FOR THIS INCONVENIENCE. THE BLACK, FLAT CORDS ARE PRICED.

TERMS: NET 30 DAYS WITH APPROVED CREDIT, C. O. D.,
VISA, MASTERCARD, AND AMERICAN EXPRESS.
ALL SHIPMENTS ARE FOB DISPLAY INNOVATIONS, INCORPORATED
ALL SHIPMENTS ARE UPS GROUND UNLESS OTHERWISE REQUESTED.
ALL PRICES ARE SUBJECT TO CHANGE WITHOUT NOTICE.

PANEL LOCKS

SIMPLIFIED EXHIBIT CONSTRUCTION.....

REDUCED SET UP COSTS.....

TOP QUALITY, ALL STEEL CONSTRUCTION.
MADE TO STAND UP TO REPEATED USAGE.....

CAN BE USED IN ALL TYPES OF JOINTS,
BACKWALL PANELS, HEADERS, STAGING SECTIONS,
PLATFORMS, AND.....

SPECIFICALLY DESIGNED FOR THE DISPLAY
INDUSTRY.....

MADE FOR USE IN 3/4" THICK MATERIAL, FOR A
TOTAL JOINT THICKNESS OF 1 1/2".....

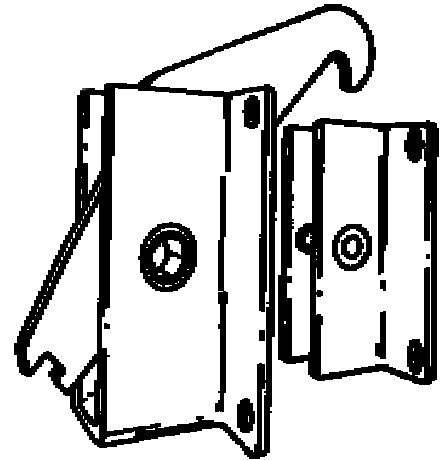

PRICING:	1 TO 100	SETS-----	\$8.95 PER SET
	101 TO 250	SETS-----	\$8.50 PER SET
	251 TO 500	SETS-----	\$8.05 PER SET
	501 TO 1000	SETS-----	\$7.60 PER SET

NOTE: LOCKS (MALE HALF) AND STRIKES (FEMALE HALF) CAN BE PURCHASED SEPERATELY.
SEE OUR PRICE LIST FOR INDIVIDUAL COSTS.

NOTE: OUR STANDARD PANEL LOCKS ARE DESIGNED TO BE USED IN PANELS WHERE TWO 3/4" THICK STILES ARE BEING LOCKED TOGETHER FOR A TOTAL THICKNESS OF 1 1/2". SHOULD YOU BE USING A MATERIAL THAT IS A DIFFERENT THICKNESS THAN THE 1 1/2" TOTAL MENTIONED ABOVE, WE HAVE OTHER STRIKES AVAILABLE THAT WILL ALLOW FOR A TOTAL STILE THICKNESS OF 1 7/16" TO 2 1/16". LISTED BELOW ARE THE EIGHT SIZES AVAILABLE, AND THE ASSOCIATED STILE THICKNESS. OUR STANDARD STRIKE IS 7/16". ALTHOUGH THE OTHER SIZES ARE AVAILABLE, WE DO NOT CARRY ANY LARGE INVENTORY OF THE NON STANDARD SIZES. THE NON-STANDARD SIZE STRIKES TAKE FROM THREE TO SIX WEEKS TO SHIP. OUR STANDARD LOCK AND STRIKE SHIP IMMEDIATELY, FROM OUR STOCK.

USE "OUR STANDARD" 7/16" STRIKE AND TWO 1/16" SPACER PLATES FOR TOTAL STILE	THICKNESS OF	1-7/16"
STRIKE SIZE 7/16"- "OUR STANDARD"-----FOR TOTAL STILE THICKNESS OF		1-1/2"
STRIKE SIZE 1/2"-----FOR TOTAL STILE THICKNESS OF		1-9/16"
STRIKE SIZE 5/8"-----FOR TOTAL STILE THICKNESS OF		1-11/16"
STRIKE SIZE 11/16"-----FOR TOTAL STILE THICKNESS OF		1-3/4"
STRIKE SIZE 3/4"-----FOR TOTAL STILE THICKNESS OF		1-13/16"
STRIKE SIZE 13/16"-----FOR TOTAL STILE THICKNESS OF		1-7/8"
STRIKE SIZE 1-1/8"-----FOR TOTAL STILE THICKNESS OF		2-1/16"

PANEL LOCK WRENCHES

MADE OF 5/16" HEX STEEL....

TWO SIZES AVAILABLE, BOTH ARE "L" SHAPED. OUR STANDARD WRENCH IS 5" ON EACH LEG, OUR EXTENDED LENGTH WRENCH IS 5" ON ONE LEG AND 12" ON THE OTHER.

IN ADDITION TO OUR TWO STOCK SIZE WRENCHES, WE CAN MAKE ANY LENGTH WRENCH NEEDED.

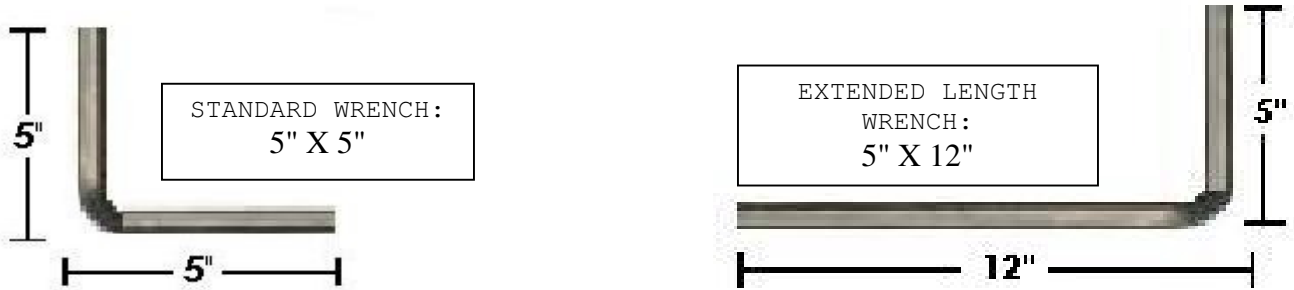

PRICING: STANDARD, 5" BY 5"-----\$4.25 EACH
EXTENDED, 5" BY 12"-----\$5.50 EACH
SPECIAL, TO YOUR SPECIFICATIONS-----\$10.00 EACH

DRILLING KIT

THIS KIT WAS DESIGNED TO ELIMINATE THE PROBLEM OF PANEL LOCK WRENCH ACCESS HOLES, IN PANELS, THAT DO NOT LINE UP EXACTLY WITH THE WRENCH HOLE IN THE LOCK. THIS MIS-ALIGNMENT REQUIRES THAT BIGGER THAN NECESSARY WRENCH ACCESS HOLES BE DRILLED THROUGH THE PANEL, AND CREATES PROBLEMS FOR THE SET UP CREW.

USING OUR DRILLING KIT WILL GAURANTEE PERFECTLY ALIGNED HOLES EVERY TIME

OUR KIT CONSISTS OF TWO DRILL BITS AND A DRILLING SLEEVE. THE KIT IS VERY SIMPLE TO USE, AND COMES IN A CONVENIENT STORAGE TUBE WITH. COMPLETE INSTRUCTIONS INCLUDED.

THE TOTAL COST PER KIT IS \$44.00

HOLE PLUGS

(FOR THE PANEL LOCK WRENCH ACCESS HOLES)

OUR STANDARD HOLE PLUGS ARE UNFINISHED METAL,
PAINT THEM ANY COLOR YOU CHOOSE.
THESE PLUGS FIT A 3/8" DIAMETER HOLE.



SOLD IN BOXES OF 100 FOR \$25.00

....ALSO AVAILABLE....

PLASTIC HOLE PLUGS IN TWO COLORS AND FIVE DIAMETERS

THE COLORS ARE BLACK AND WHITE
(ALL PLUGS ARE PAINTABLE)



THE DIAMETERS ARE 1/4", 5/16", 3/8", 7/16", AND 1/2"

PRICING:

1/4"	DIAMETER, IN BLACK OR WHITE.....	\$20.00 PER 250
5/16"	DIAMETER, IN BLACK OR WHITE.....	\$20.00 PER 250
3/8"	DIAMETER, IN BLACK OR WHITE.....	\$20.00 PER 250
7/16"	DIAMETER, IN BLACK OR WHITE.....	\$20.00 PER 250
1/2"	DIAMETER, IN BLACK OR WHITE.....	\$20.00 PER 250

AND, HOLE PLUGS WITH LARGER HEADS

FIVE DIAMETERS

NATURAL COLOR NYLON, WITH MATTE FINISH

<u>DIAMETER</u>	<u>HEAD DIAMETER</u>	<u>FINISH</u>	<u>PRICE</u>
1/4"27/64"MATTE/NATURAL....	\$20.00/250
5/16"29/64"MATTE/NATURAL....	\$20.00/250
3/8"37/64"MATTE/NATURAL....	\$20.00/250
7/16"39/64"MATTE/NATURAL....	\$20.00/250
1/2"43/64"MATTE/NATURAL....	\$20.00/250

CARRIAGE BOLTS



ZINC PLATED STEEL, FULL THREAD

1/4-20 X 1-1/2"-\$42.00 PER CASE OF 1000, \$6.60 PER 100
 1/4-20 X 2"-----\$41.00 PER CASE OF 800, \$7.95 PER 100
 1/4-20 X 2-1/2"--\$44.00 PER CASE OF 700, \$9.50 PER 100
 1/4-20 X 3"-----\$43.00 PER CASE OF 600, \$11.00 PER 100
 1/4-20 X 6"-----\$41.00 PER CASE OF 300, \$21.00 PER 100

1/4-20 CARRIAGE BOLTS ARE AVAILABLE IN MANY OTHER LENGTHS, UP TO 8". ALSO AVAILABLE ARE 3/16", 5/16", 3/8", 7/16", 1/2", 5/8", AND 3/4" DIAMETERS, WITH LENGTHS TO 14". ALL CARRIAGE BOLTS NOT LISTED IN THE PRICE SECTION ABOVE ARE SOLD BY THE CASE ONLY. CASE QUANTITIES VARY FROM 20 PIECES TO 3000 PIECES, DEPENDING ON SIZE. PLEASE CALL FOR QUOTE.

(SEE OUR "TORQUE WASHERS" ON PAGE 10, A GREAT COMPANION PART FOR CARRIAGE BOLTS)

EXHIBIT BOLTS

USED WITH OUR WASHER BASE WING NUTS, THESE BOLTS DRAW JOINTS TIGHTLY TOGETHER WITHOUT DAMAGING WOOD FRAMING. BUILT LIKE A CARRIAGE BOLT, BUT WITH A 1" DIAMETER HEAD, WHICH ALLOWS PRESURE TO SPREAD OVER A MUCH LARGER AREA.

USE ON EXHIBIT PANELS, CRATES, ETC.

ZINC PLATED, AVAILABLE IN FOUR STOCK LENG (OTHER LENGTHS AVAILABLE)



1/4-20 X 1"-----PER 100, \$24.50
 1/4-20 X 2"-----PER 100, \$28.75
 1/4-20 X 2-1/2"---PER 100, \$34.00
 1/4-20 X 3"-----PER 100, \$38.50

NUTS SOLD SEPERATELY



WASHER BASE WING NUTS

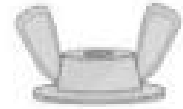

SPEEDS EXHIBIT SET UP AND DISMANTLE WHEN USING
THE "NUT AND BOLT" METHOD OF ASSEMBLY

DIE CAST IN ZINC ALLOY

1/4-20 THREAD, WITH 7/8" WASHER BASE

ELIMINATES THE NEED FOR A SEPERATE WASHER AND SPREADS
THE PRESSURE OF THE NUT OVER A BROADER AREA

500 PIECES FOR \$85.00, 1000 TO
4999 PIECES FOR \$155.00 PER THOUSAND, 5000
OR MORE PIECES FOR \$135.00 PER THOUSAND

5/16-18 AND 3/8-16 WING NUTS WITH 7/8" WASHER BASE ARE
AVAILABLE: 500 PIECES FOR \$85.00, 1000 TO
4999 PIECES FOR \$155.00 PER THOUSAND, 5000
OR MORE PIECES FOR \$135.00 PER THOUSAND

WING NUTS ARE ALSO AVAILABLE IN 10-24, 10-32,
AND 8-32 THREAD



1/4-20 WING SCREWS



FOUR LENGTHS; 1/2", 3/4", 1", and 1 1/2"
DIE CAST ZINC ALLOY

BASE (UNDERSIDE OF HEAD) DIAMETER IS .045

SOLD IN PACKAGES OF 100
100 TO 2000 PIECES, \$34.00 PER 100
2100 PIECES AND ABOVE \$32.00 PER 100

THUMB SCREWS



THUMB SCREWS ARE SIMILAR TO WING SCREWS, EXCEPT THEY ARE COLD FORGED, NOT DIECAST, AND THEREFORE MUCH STRONGER. THESE THUMB SCREWS HANE A SHOULDER UNDER THE HEAD WHICH ACTS AS A WASHER, BUT WE STILL RECOMMEND USING A LARGER WASHER ON WOOD SURFACES. THUMB SCREWS ARE AVAILABLE IN MANY LENGTHS AND DIAMETERS. WE HAVE ¼-20 BY 2 ½" IN BAGS OF 100, OR CASES OF 500. OTHER SIZES, FROM 6-32 UP TO 3/8-16 ARE AVAILABLE IN MANY LENGTHS, IN CASE QUANTITIES, WHICH VARY.

PRICING: 1/4-20 X 2 1/2"-----100 PIECES FOR \$28.50
CASE OF 500 FOR \$88.50

TORQUE WASHERS 1/4"

(FOR ¼" CARRIAGE BOLTS)



Torque washers are made to be used with ¼" carriage bolts. They serve two purposes, to increase the head diameter of the carriage bolt to 1", spreading the bolt head load over a much bigger area, and because the washers have a square center hole and prongs in the bottom side of the washer, they lock the carriage bolt in place, and prevent it from turning during tightening or loosening of the nut. An excellent companion piece for the carriage bolt and washer base wing nut.

PRICING:-----250 TO 1000 PIECES, PER 250 FOR \$58.70
1250 PLUS PIECES, PER 250 \$52.50

1/4-20, 5/16-18, and 3/8-16 TEE NUTS

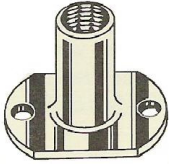

A TRUE "T" NUT AND
THE CHOICE OF THE EXHIBIT/DISPLAY INDUSTRY
FAST, PERMANENT INSTALLATION, AND LONG LIFE

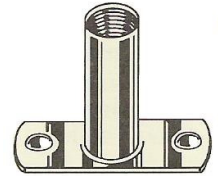

1/4-20 MOUNTING PLATE IS 1/2" BY 1"
THE THREADED BARREL IS 11/32" DEEP

5/16-18 MOUNTING PLATE IS 1/2" X 1"
THE THREADED BARREL IS 7/8" DEEP

3/8-16 MOUNTING PLATE IS 5/8" X 1"

THE THREADED BARREL IS 7/16" DEEP

(PLEASE NOTE THAT THE 3/8" T NUT COMES
AS PICTURED ON THE LEFT. 1/4" and 5/16"
T NUTS ARE AS SHOWN ON THE RIGHT.)

1/4-20 T NUTS SOLD IN PACKAGES OF 250 FOR \$59.00
5/16-18 T NUTS SOLD IN PACKAGES OF 100 FOR \$41.00
3/8-16 T NUTS SOLD IN PACKAGES OF 100 FOR \$26.00

HEX DRIVE, KNIFE THREAD, INSERTS



AVAILABLE IN THREE THREAD SIZES

1/4-20, 5/16-18, AND 3/8-16



AN ECONOMICAL, EFFECTIVE, WAY TO USE
MACHINE THREAD FASTENERS IN WOOD. THESE INSERTS
DRIVE IN WITH A HEX DRIVER, AND HAVE A FLANGE
TO PREVENT THEM FROM GOING IN TOO FAR
INSERTS ARE DIE CAST ZINC

THREAD SIZE	LENGTH	PILOT HOLE SIZE	DRIVER SIZE
1/4-20	1/2"	5/16" DIAMETER	6MM
1/4-20	3/4"	5/16" DIAMETER	6MM
5/16-18	1"	7/16"-1/2" DIA.	8MM
3/8-16	1"	1/2"-33/64" DIA.	10MM

PRICING: 100 PIECES, 1/4-20 X 1/2" \$19.00
100 PIECES, 1/4-20 X 3/4" \$22.00
100 PIECES, 5/16-18 X 1" \$26.30
100 PIECES, 3/8-16 X 1" \$51.65

ONE HEX DRIVER IS INCLUDED IN EACH PACKAGE OF 100
ADDITIONAL DRIVERS: 6MM-\$4.30, 8MM-\$8.40, 10MM-\$10.20

KNIFE THREAD INSERTS, NON HEX DRIVE



KNIFE THREAD INSERTS ARE MEANT TO BE USED IN
WOOD WHERE MACHINE THREADS ARE NEEDED. THE
INTERNAL THREAD IS 1/4-20, THE REQUIRED HOLE
IN THE WOOD IS 3/8" DIAMETER. THE BARREL
LENGTH IS 1/2", AND THE INSERTS ARE BRASS
SOLD IN PACKAGES OF 100 FOR \$35.00
DRIVERS FOR THESE INSERTS ARE SOLD
SEPERATELY AT \$11.00 EACH

VENT PLUGS



USE TO VENT LIGHT BOXES, HEADERS, ETC.

PERMIT THE PASSAGE OF AIR FOR VENTILATION
AND HEAT DISSIPATION

MATTE BLACK FINISH

1" DIAMETER, IN BLACK-----\$17.50 PER 100 PIECES

1-1/2" DIAMETER, IN BLACK--\$28.00 PER 100 PIECES

2" DIAMETER, IN BLACK-----\$36.00 PER 100 PIECES

HAND HOLE PLUGS

FOR USE IN PANELS REQUIRING A HOLE LARGE
ENOUGH FOR HAND ACCESS

FITS A 4" DIAMETER HOLE, 4 3/16" OVERALL DIAM

NYLON WITH MATTE BLACK FINISH

SOLD 50 TO A BOX FOR \$130.00 OR INDIVIDUALLY FOR \$2.60



CRATE HINGES AND HASPS

6" SAFETY HASP, ZINC PLATED STEEL

PRICING: 1 - 50 PIECES-----\$3.75 each

50 PLUS PIECES-----\$3.55 each

(SCREWS ARE NOT INCLUDED)



**6" STRAP HINGES, STANDARD DUTY
ZINC PLATED STEEL**

PRICING: 1 - 50 PIECES-----\$2.00 each
51 PLUS PIECES-----\$1.90 each
(SCREWS ARE NOT INCLUDED)



6" HINGE HASP, ZINC PLATED STEEL

PRICING: 1 - 50 PIECES-----\$3.90 each
51 PLUS PIECES-----\$3.70 each
(SCREWS ARE NOT INCLUDED)



**STRAP HINGES, HEAVY DUTY
ZINC PLATED STEEL**

PRICING: 1 - 50 PIECES-----\$3.00 each
51 plus PIECES-----\$2.85 each
(SCREWS ARE NOT INCLUDED)



CRATING AND PACKING FELT



THIS FELT IS WELL SUITED FOR CRATING AND GENERAL PACKAGING. WE CARRY FIVE WIDTHS, AND TWO THICKNESSES, EACH WITH AND WITHOUT ADHESIVE BACKING ALL ON 50 FOOT OR 100 FOOT ROLLS, DEPENDING ON THE THICKNESS. THE COLOR IS WHITE.

1/4" THICK X 50' X 1" WIDE ROLL W/ADHESIVE BAC	-----1-10	ROLLS \$12.05
	11 PLUS ROLLS AT	\$11.30
1/4" THICK X 50' X 1 1/2" WIDE ROLL W/ADHESIVE BACK	-----1-10	ROLLS \$17.00
	11 PLUS ROLLS AT	\$16.25
1/4" THICK X 50' X 2" WIDE ROLL W/ADHESIVE BACK	-----1-10	ROLLS \$21.85
	11 PLUS ROLLS AT	\$21.10
1/4" THICK X 50' X 3" WIDE ROLL W/ADHESIVE BACK	-----1-10	ROLLS \$30.75
	11 PLUS ROLLS AT	\$30.00
1/4" THICK X 50' X 1" WIDE ROLL, NO ADHESIVE	-----1-10	ROLLS \$9.10
	11 PLUS ROLLS AT	\$8.35
1/4" THICK X 50' X 1 1/2" WIDE ROLL, NO ADHESIVE	-----1-10	ROLLS \$12.65
	11 PLUS ROLLS AT	\$11.90
1/4" THICK X 50' X 2" WIDE ROLL, NO ADHESIVE	-----1-10	ROLLS \$16.05
	11 PLUS ROLLS AT	\$15.30
1/4" THICK X 50' X 3" WIDE ROLL, NO ADHESIVE	-----1-10	ROLLS \$22.40
	11 PLUS ROLLS AT	\$21.65
1/8" THICK X 100' X 1" WIDE ROLL W/ADHESIVE BACK	-----1-10	ROLLS \$13.70
	11 PLUS ROLLS AT	\$12.95
1/8" THICK X 100' X 1 1/2" WIDE ROLL W/ADHESIVE BACK	-----1-10	ROLLS \$19.10
	11 PLUS ROLLS AT	\$18.35
1/8" THICK X 100' X 2" WIDE ROLL W/ADHESIVE BACK	-----1-10	ROLLS \$26.60
	11 PLUS ROLLS AT	\$25.85
1/8" THICK X 100' X 3" WIDE ROLL W/ADHESIVE BACK	-----1-10	ROLLS \$35.20
	11 PLUS ROLLS AT	\$34.45
1/8" THICK X 100' X 1" WIDE ROLL, NO ADHESIVE	-----1-10	ROLLS \$9.40
	11 PLUS ROLLS AT	\$8.65
1/8" THICK X 100' X 1 1/2" WIDE ROLL, NO ADHESIVE	-----1-10	ROLLS \$12.65
	11 PLUS ROLLS AT	\$11.90
1/8" THICK X 100' X 2" WIDE ROLL, NO ADHESIVE	-----1-10	ROLLS \$16.05
	11 PLUS ROLLS AT	\$15.30
1/8" THICK X 100' X 3" WIDE ROLL, NO ADHESIVE	-----1-10	ROLLS \$22.45
	11 PLUS ROLLS AT	\$21.70

MULTIPLE OUTLET POWER STRIPS

Seven outlet power strip:

SEVEN, GROUNDED 15 AMP OUTLETS, 15 AMP CIRCUIT BREAKER, FIRE RETARDANT PLASTIC CASE, FOUR FOOT, THREE WIRE, FOURTEEN GAUGE CORD, ON/OFF SWITCH, UL LISTED. WITH SURGE SUPPRESSION. (THE GROUND LUG IS ON THE SIDE, AS PICTURED LEFT)



MODEL	AMPS	WATTS	PRICE
MOSP 64-----15-----1875----			\$18.25 EACH

Six outlet power strip:

MADE BY PRIME WIRE, SURGE PROTECTION, LIGHTED ON/OFF SWITCH, 14/3 CORD, 4' LONG THE OUTLETS ARE TURNED TO THE SIDE FOR BETTER SPACE UTILIZATION, TWO OF THE OUTLETS ARE WIDELY SPACED FOR USE WITH TRANSFORMERS.

1 - 24 for \$6.50 each,
25 and up for \$6.15 each



WHEN USING EITHER MULTIPLE OUTLET STRIP TO PLUG IN A GROUP OF TRANSFORMERS, EVERY OUTLET CAN BE ACCESSED BY USING OUR TRANSFORMER ADAPTER CORD, A 14" LONG, 14 GAUGE CORD, THAT PLUGS INTO THE STRIP. THE TRANSFORMER IS PLUGGED INTO THIS CORD, ALLOWING THE TRANSFORMER TO LIE ON THE FLOOR NEXT TO THE STRIP, MAKING ALL OUTLETS USABLE.

PART #J3-14 \$4.00 EACH

HEAVY DUTY, FOUR WAY, ALL RUBBER, THREE WIRE, GROUNDED, POWER DISTRIBUTION CORDS, **BLACK**

CATALOG NUMBER	LENGTH	AMPS	WATTS	PRICE
----------------	--------	------	-------	-------

12/3 SJOW .475 O.D. BLACK RUBBER CORD WITH MOLDED VINYL PLUG.

M3 22-(SHORTIE)---	2'-----	15---	1875-----	CALL
M3 102-----	10'-----	15---	1875-----	CALL
M3 152-----	15'-----	15---	1875-----	CALL
M3 252-----	25'-----	15---	1875-----	CALL
M3 502-----	50'-----	15---	1875-----	CALL
M3 1002-----	100'-----	15---	1875-----	CALL

14/3 SJOW .390 O.D. BLACK RUBBER CORD WITH MOLDED VINNYL PLUG.

M3 104-----	10'-----	15---	1875-----	CALL
M3 154-----	15'-----	15---	1875-----	CALL
M3 254-----	25'-----	15---	1875-----	CALL
M3 504-----	50'-----	15---	1875-----	CALL

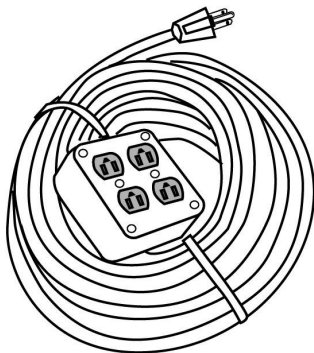

HEAVY DUTY, ALL RUBBER, THREE WIRE, GROUNDED, EXTENSION CORDS

OIL RESISTANT, FLEXIBLE TO -34 DEGREES F.,

MOLDED VINYL MALE AND FEMALE PLUGS, **BLACK**

AVAILABLE IN BOTH SJ CORD AND SO CORD. (SO CORDS HAVE A HEAVIER OUTSIDE RUBBER COATING AND WILL WITHSTAND HARDER USE. THESE SO CORDS ARE REQUIRED BY SOME EXHIBIT HALLS WHERE CORDS COULD BE WALKED ON.)

S3 SERIES

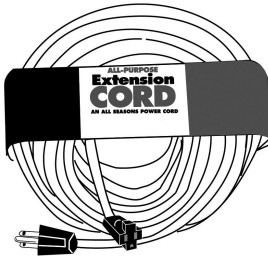

CATALOG NUMBER	LENGTH	AMPS	WATTS	PRICE
12/3 SO CORDS, SOWA UL .635 O.D., BLACK RUBBER				
S3 102	10'	15	1875	CALL
S3 152	15'	15	1875	CALL
S3 252	25'	15	1875	CALL
S3 502	50'	15	1875	CALL
S3 1002	100'	15	1875	CALL
14/3 SO CORDS, SOWA UL .500 O.D., BLACK RUBBER				
S3 104	10'	15	1875	CALL
S3 154	15'	15	1875	CALL
S3 254	25'	15	1875	CALL
S3 504	50'	15	1875	CALL
S3 1004	100'	13	1325	CALL

J3 SERIES



10/3 SJ CORDS, SJOW-A, UL .560 O.D., BLACK RUBBER				
J3 110	10'	15	1875	CALL
J3 1510	15'	15	1875	CALL
J3 2510	25'	15	1875	CALL
J3 5010	50'	15	1875	CALL
J3 1010	100'	15	1875	CALL
12/3 SJ CORDS, SJOW-A, UL .475 O.D., BLACK RUBBER				
J3 102	10'	15	1875	CALL
J3 152	15'	15	1875	CALL
J3 252	25'	15	1875	CALL
J3 502	50'	15	1875	CALL
J3 1002	100'	15	1875	CALL
14/3 SJ CORDS, SJOW-A, UL .390 O.D., BLACK RUBBER				
J3 104	10'	15	1875	CALL
J3 154	15'	15	1875	CALL
J3 254	25'	15	1875	CALL
J3 504	50'	15	1875	CALL
J3 1004	100'	13	1375	CALL
16/3 SJ CORDS, SJOW-A, UL .365 O.D., BLACK RUBBER				
J3 106	10'	13	1625	CALL
J3 156	15'	13	1625	CALL
J3 256	25'	13	1625	CALL
J3 506	50'	13	1625	CALL
J3 1006	100'	10	1250	CALL

TRIPLE OUTLET, THREE WIRE, GROUNDED INDOOR/OUTDOOR, EXTENSION CORDS, **BLACK**

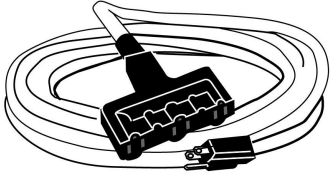

14/3 SJOW UL .390 O.D., BLACK RUBBER CORD
MOLDED VINYL MALE AND FEMALE PLUGS

CATALOG NUMBER	LENGTH	AMPS	WATTS	PRICE
TCR 154	15'	15	1875	CALL
TCR 254	25'	15	1875	CALL
TCR 504	50'	15	1875	CALL
TCR 1004	100'	13	1625	CALL

BLACK CORDS WITH MALE PLUG ONLY:

(PLUG DIAMETER 1 1/4")

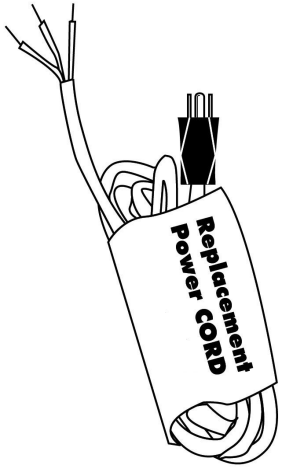

CATALOG NUMBER	LENGTH	AMPS	WATTS	PRICE
14/3 SJOW-A UL .390 O.D.,				BLACK RUBBER
MR3 64	6'	15	1875	CALL
MR3 94	9'	15	1875	CALL
MR3 124	12'	15	1875	CALL
16/3 SJOW-A UL .365 O.D.,				BLACK RUBBER
MR3 66	6'	13	1625	CALL
MR3 96	9'	13	1625	CALL
MR3 126	12'	13	1625	CALL
18/3 SJOW-A UL .330 O.D.,				BLACK RUBBER
MR3 68	6'	10	1250	CALL
MR3 98	9'	10	1250	CALL
MR3 128	12'	10	1250	CALL

BLACK CORDS WITH FEMALE PLUG ONLY:

(PLUG DIA. 1 1/4")

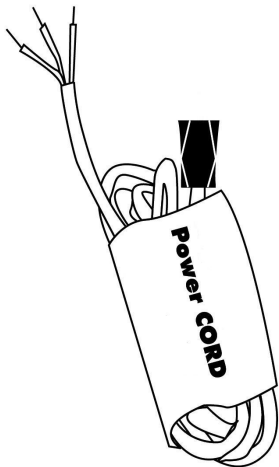

14/3 SJOW-A UL .390 O.D.,				BLACK RUBBER
FR3 64	6'	15	1875	CALL
FR3 94	9'	15	1875	CALL
FR3 124	12'	15	1875	CALL
16/3 SJOW-A UL .365 O.D.,				BLACK RUBBER
FR3 66	6'	13	1625	CALL
FR3 96	9'	13	1625	CALL
FR3 126	12'	13	1625	CALL
18/3 SJOW-A UL .330 O.D.,				BLACK RUBBER
FR3 68	6'	10	1250	CALL
FR3 98	9'	10	1250	CALL
FR3 128	12'	10	1250	CALL

FLAT EXTENSION CORDS, **BLACK** CORD WITH MOLDED VINYL MALE AND FEMALE PLUGS.

CATALOG NUMBER	LENGTH	AMPS	WATTS	DIMENSIONS	PRICE
12/3 SPT-3 WITH GROUND, BLACK VINYL CORD					
11812115	15'	15	1875	19/64" X 5/8"	\$12.00
11821025	25'	15	1875	19/64" X 5/8"	\$21.00
11821050	50'	15	1875	19/64" X 5/8"	\$38.00
11821100	100'	15	1875	19/64" X 5/8"	\$73.00
14/3 SPT-3 WITH GROUND, BLACK VINYL CORD					
11814115	15'	15	1875	15/64" X 33/64"	\$11.50
11814125	25'	15	1875	15/64" X 33/64"	\$18.50
11814150	50'	15	1875	15/64" X 33/64"	\$34.00

FLAT EXTENSION CORDS, **ORANGE** CORD WITH MOLDED VINYL MALE AND FEMALE PLUGS.

CATALOG NUMBER	LENGTH	AMPS	WATTS	DIMENSIONS	PRICE
12/3 SPT-2 WITH GROUND, ORANGE VINYL CORD					
Y3 102	10'	15	1875	19/64" X 5/8"	CALL
Y3 152	15'	15	1875	19/64" X 5/8"	CALL
Y3 252	25'	15	1875	19/64" X 5/8"	CALL
Y3 502	50'	15	1875	19/64" X 5/8"	CALL
Y3 1002	100'	15	1875	19/64" X 5/8"	CALL
14/3 SPT-2 WITH GROUND, ORANGE VINYL CORD					
Y3 104	10'	15	1875	15/64" X 33/64"	CALL
Y3 154	15'	15	1875	15/64" X 33/64"	CALL
Y3 254	25'	15	1875	15/64" X 33/64"	CALL
Y3 504	50'	15	1875	15/64" X 33/64"	CALL
Y3 1004	100'	13	1625	15/64" X 33/64"	CALL
16/3 SPT-2 WITH GROUND, ORANGE VINYL CORD					
Y3 106	10'	13	1625	3/16" X 7/16"	CALL
Y3 156	15'	13	1625	3/16" X 7/16"	CALL
Y3 256	25'	13	1625	3/16" X 7/16"	CALL
Y3 506	50'	13	1625	3/16" X 7/16"	CALL

THREE WAY GROUNDED TAP :

CONVERTS ONE GROUNDED OUTLET INTO THREE GROUNDED OUTLETS, NOT RECOMMENDED FOR PERMANENT INSTALLATION. **CATALOG NUMBER TB 12, \$3.70**

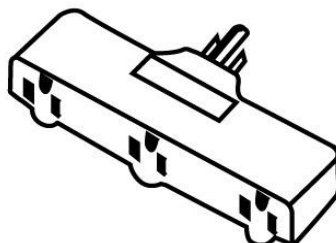

PANEL LOCK INSTALLATION INSTRUCTIONS

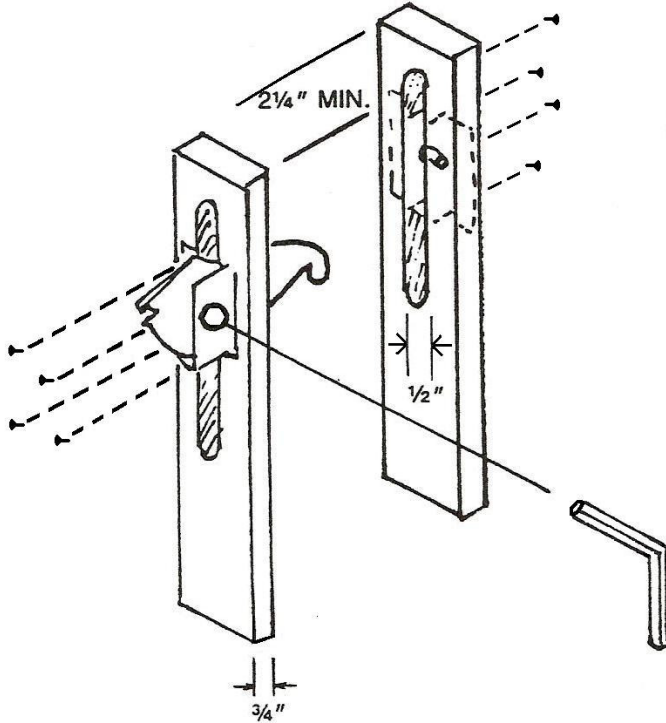

1. Rout a 1/2" X 6" slot in both pieces to be joined.
 2. Mount lock and strike as shown.
 3. Cover panels and drill a 3/8" access hole for hex wrench.
- Note: We have a drilling kit available that will give perfectly aligned wrench access holes every time in double sided panels.**

